

# Mini-Box pico-SAM9G45 Connectors Pinout (Schematic version 1.1f)

- I/O INTERFACE CONNECTOR RIGHT SIDE [J7]**

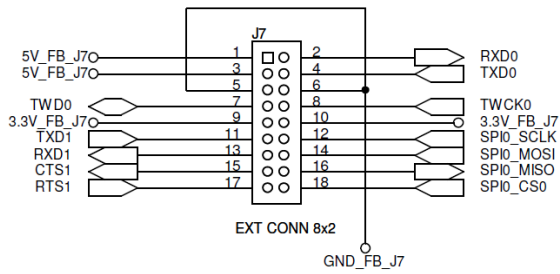

SIDE VIEW

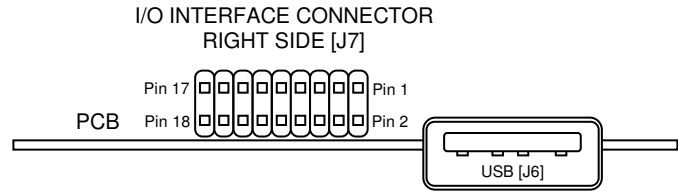

- I/O INTERFACE CONNECTOR LEFT SIDE [J9]**

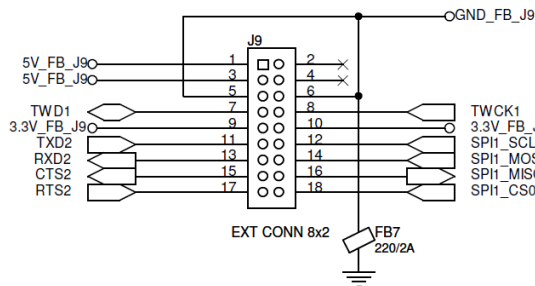

SIDE VIEW

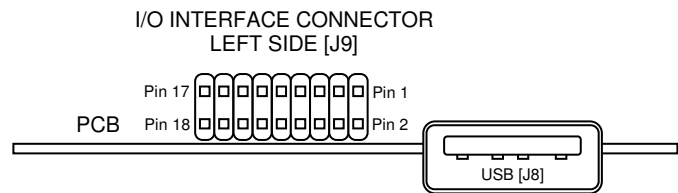

- [LEFT] [OK] [RIGHT] & USER BUTTONS [J14]**

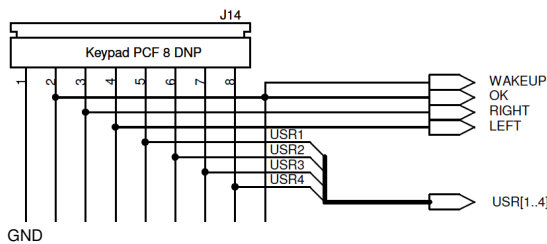

TOP VIEW

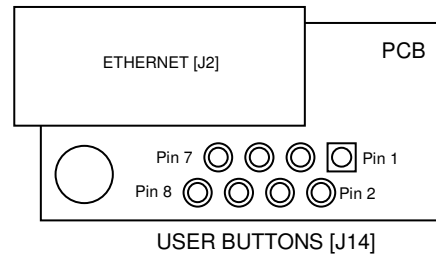

- DC IN [J15], BACK POWER [J21], ANALOG IN [J16]**

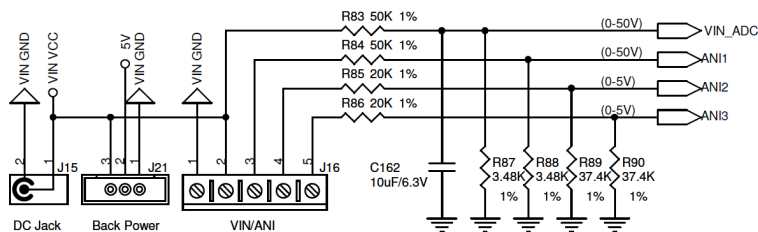

SIDE VIEW

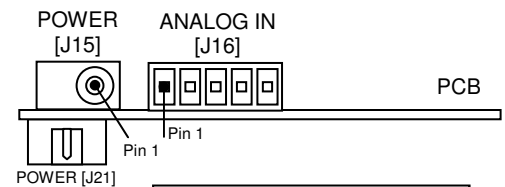

TOP VIEW

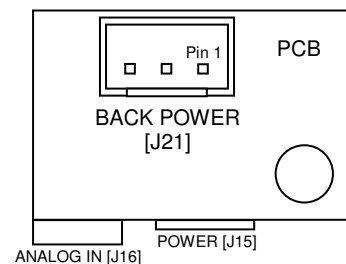

- LCD CONNECTOR [J12]

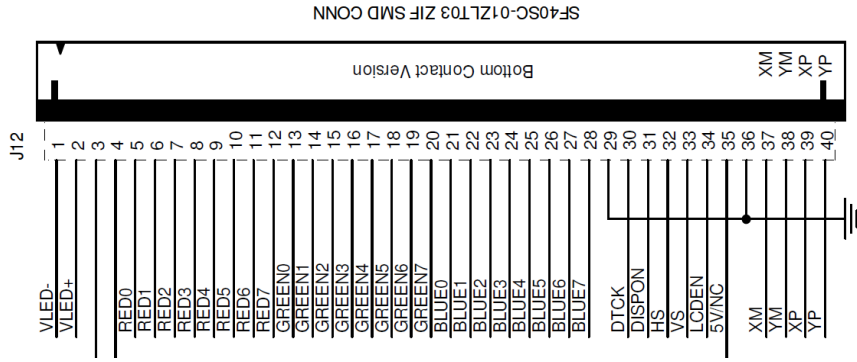

TOP VIEW

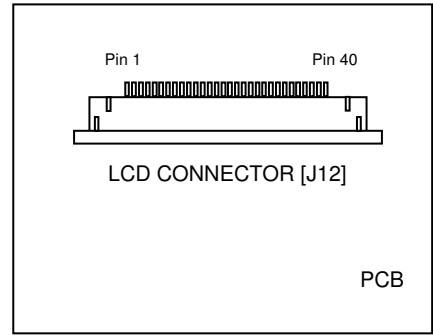

- TOUCH PANEL CONNECTOR [J23]

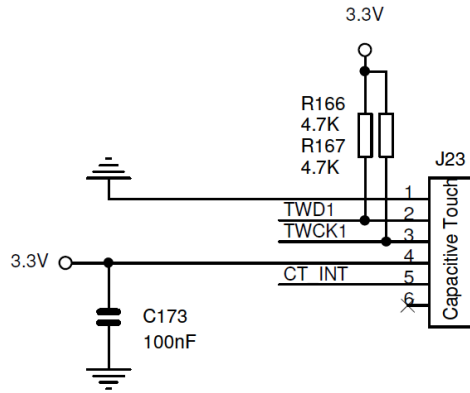

TOP VIEW

